



# DSK12L THRU DSK16L

## Surface Mount Low VF Schottky Rectifiers

Reverse Voltage - 20 to 60 V  
Forward Current - 1.0 A

### FEATURES

- Metal silicon junction, majority carrier conduction
- For surface mounted applications
- Low power loss, high efficiency
- High forward surge current capability
- For use in low voltage, high frequency inverters, free wheeling, and polarity protection applications

### MECHANICAL DATA

- Case: SOD-123FL
- Terminals: Solderable per MIL-STD-750, Method 2026
- Approx. Weight: 15mg 0.00048oz

### PINNING

PIN	DESCRIPTION
1	Cathode
2	Anode

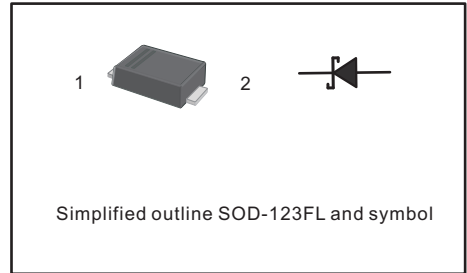

### Absolute Maximum Ratings and Electrical characteristics

Ratings at 25 °C ambient temperature unless otherwise specified. Single phase, half wave, 60Hz resistive or inductive load, for capacitive load, derate by 20 %

Parameter	Symbols	DSK12L	DSK14L	DSK16L	Units
Maximum Repetitive Peak Reverse Voltage	$V_{RRM}$	20	40	60	V
Maximum RMS voltage	$V_{RMS}$	14	28	42	V
Maximum DC Blocking Voltage	$V_{DC}$	20	40	60	V
Maximum Average Forward Rectified Current	$I_{F(AV)}$	1.0			A
Peak Forward Surge Current, 8.3ms Single Half Sine-wave Superimposed on Rated Load (JEDEC method)	$I_{FSM}$	35			A
Max Instantaneous Forward Voltage at 1 A	$V_F$	0.45		0.55	V
Maximum DC Reverse Current $T_a = 25^\circ\text{C}$ at Rated DC Reverse Voltage $T_a = 100^\circ\text{C}$	$I_R$	0.3 10	0.2 5		mA
Typical Junction Capacitance <sup>1)</sup>	$C_j$	180		80	pF
Typical Thermal Resistance <sup>2)</sup>	$R_{\theta JA}$	115			°C/W
Operating Junction Temperature Range	$T_j$	-55 ~ +125			°C
Storage Temperature Range	$T_{stg}$	-55 ~ +150			°C

1) Measured at 1MHz and applied reverse voltage of 4 V D.C.

2) P.C.B. mounted with 0.2 X 0.2" (5 X 5 mm) copper pad areas.



# DSK12L THRU DSK16L

## Surface Mount Low VF Schottky Rectifiers

**Characteristic Curves** (T = 25 °C unless otherwise noted)

**Fig.1 Forward Current Derating Curve**

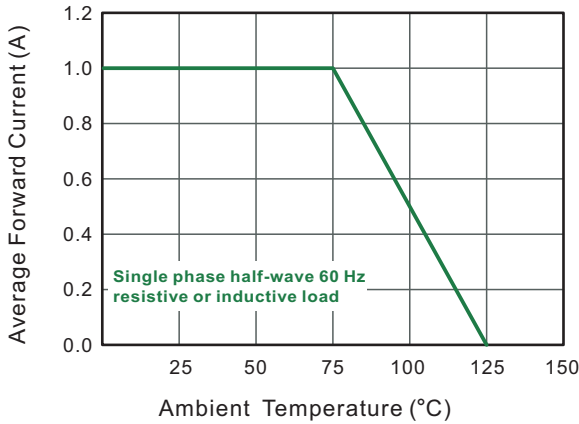

**Fig.2 Typical Reverse Characteristics**

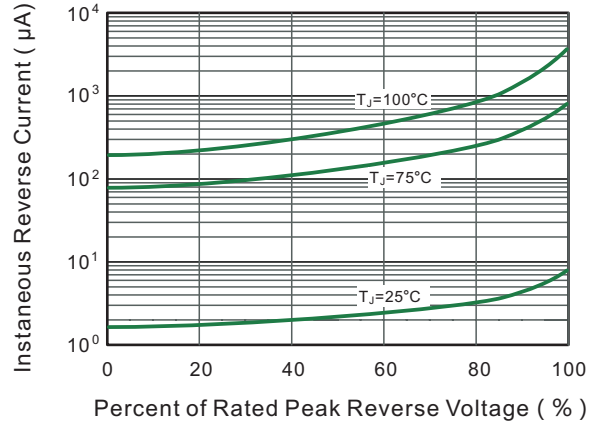

**Fig.3 Typical Forward Characteristic**

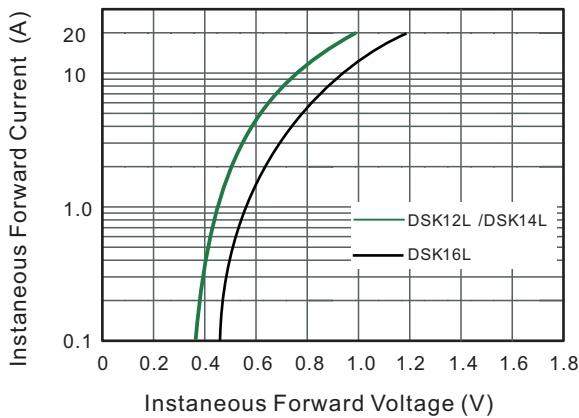

**Fig.4 Typical Junction Capacitance**

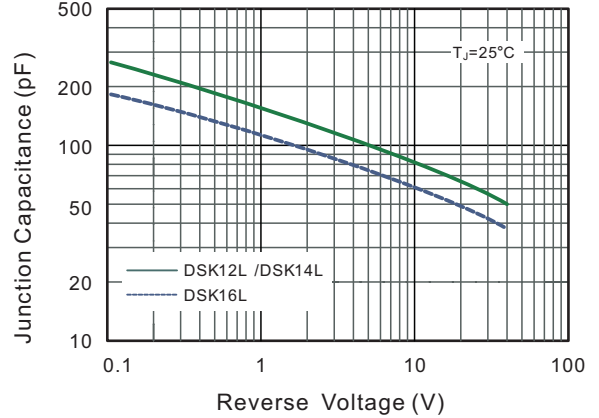

**Fig.5 Maximum Non-Repetitive Peak Forward Surge Current**

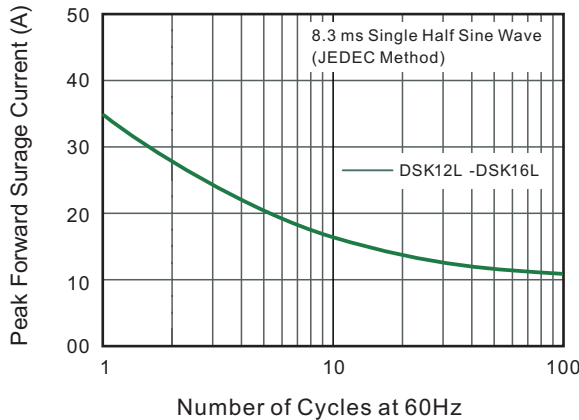

**Fig.6 Typical Transient Thermal Impedance**

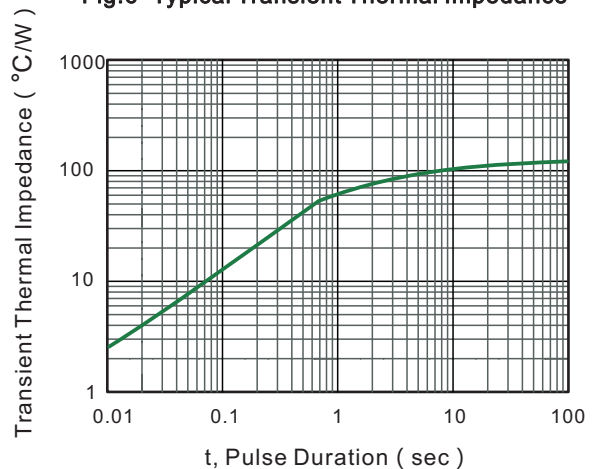



# DSK12L THRU DSK16L

## Surface Mount Low VF Schottky Rectifiers

### PACKAGE OUTLINE

Plastic surface mounted package; 2 leads

SOD-123FL

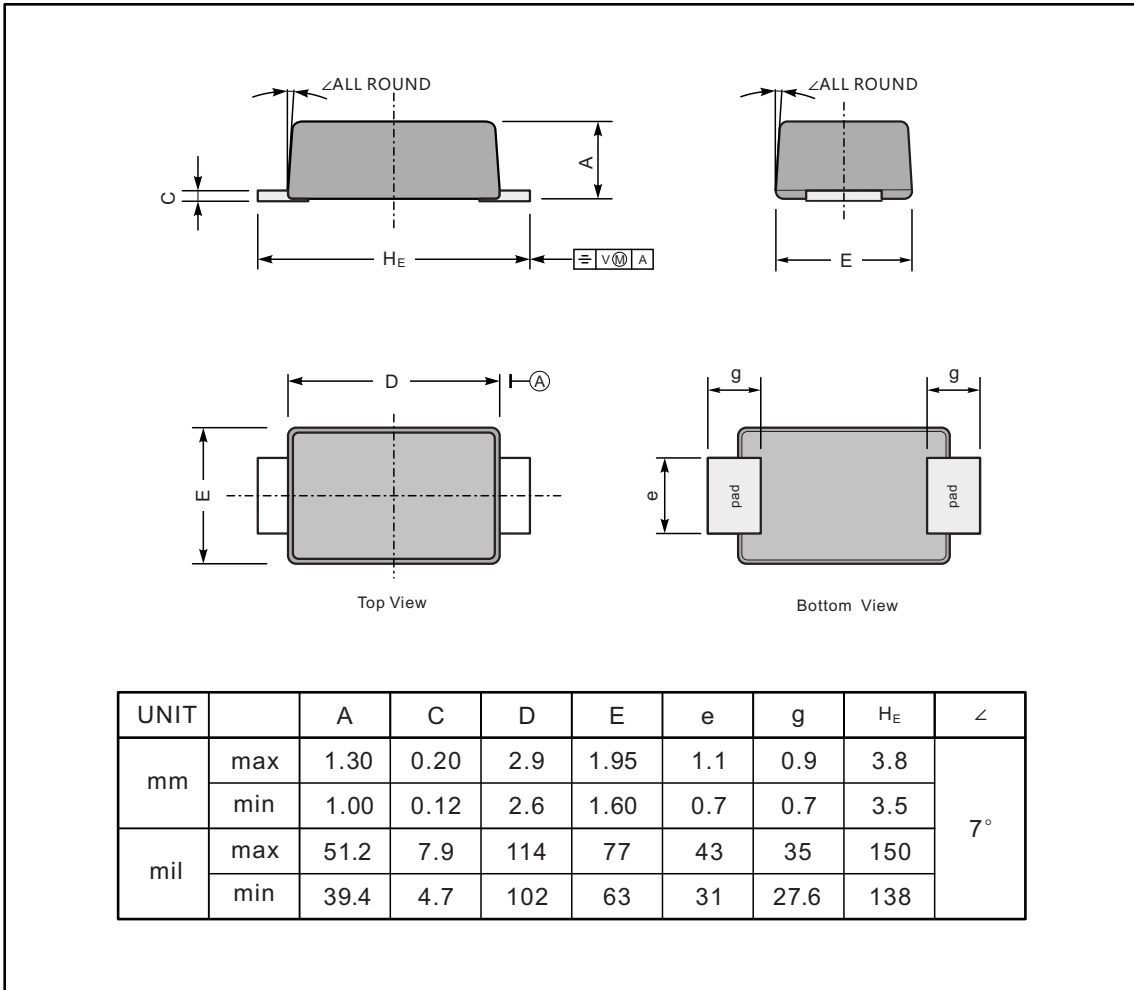

### The recommended mounting pad size

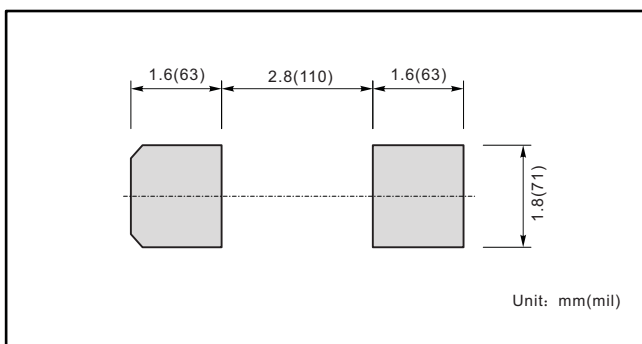

### Marking

Type number	Marking code
DSK12L	SL12
DSK14L	SL14
DSK16L	SL16