



HER101 THRU HER108

Ultra Fast Rectifiers

FEATURES

- Plastic package has Underwriters Laboratory Flammability Classification 94V-O utilizing Flame Retardant Epoxy Molding Compound.
- Void-free Plastic in a DO-41 package.
- 1.0 ampere operation at $T_A=55$ With no thermal runaway.
- Ultra Fast switching for high efficiency.
- Exceeds environmental standards of MIL-S-19500/228

MECHANICAL DATA

Case: Molded plastic, DO-41

Terminals: Axial leads, solderable per MIL-STD-202, method 208 guaranteed

Polarity: Band denotes cathode

Mounting position: Any

Weight: 0.013ounce, 0.3gram

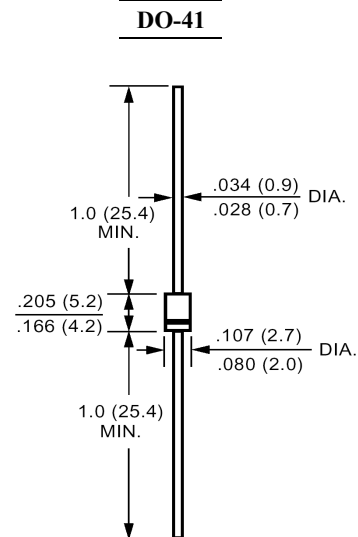

Dimensions in inches and (millimeters)

Maximum Ratings and Electrical Characteristics

Ratings at 25 ambient temperature unless otherwise specified.

Single phase, half wave, 60Hz, resistive or inductive load.

For capacitive load, derate current by 20%.

	Symbols	HER101	HER102	HER103	HER104	HER105	HER106	HER107	HER108	Units
Maximum Recurrent Peak Reverse Voltage	V_{RRM}	50	100	200	300	400	600	800	1000	Volts
Maximum RMS Voltage	V_{RMS}	35	70	140	210	280	420	560	700	Volts
Maximum DC Blocking Voltage	V_{DC}	50	100	200	300	400	600	800	1000	Volts
Maximum Average Forward Rectified Current .375"(9.5mm) Lead Length at $T_A=55$	$I_{(AV)}$	1.0								Amp
Peak Forward Surge Current, 8.3ms single half-sine-wave superimposed on rated load (JEDEC method)	I_{FSM}	30								Amp
Maximum Forward Voltage at 1.0A and $T_A=25$	V_F	1.0		1.3		1.7				Volts
Maximum Reverse Current at $T_j=25$ at Rated DC Blocking Voltage $T_j=100$	I_R	500								uAmp
Typical Junction Capacitance (Note 1)	C_J	17								pF
Maximum Reverse Recovery Time (Note 2)	T_{RR}	50				75				nS
Typical Thermal Resistance (Note 3)	$R_{\theta JA}$	60								/W
Operating and Storage Temperature Range	T_j, T_{stg}	-55 to +125								

NOTES:

1- Measured at 1 MHz and applied reverse voltage of 4.0 VDC.

2- Reverse Recovery Test Conditions : $I_F=.5A$, $I_R=1A$, $I_{RR}=.25A$.

3- Thermal Resistance from Junction to Ambient at 0.375"(9.5mm) lead length P.C.B. Mounted.



HER101 THRU HER108

Ultra Fast Rectifiers

RATINGS AND CHARACTERISTIC CURVES

FIG. 1- REVERSE RECOVERY TIME CHARACTERISTIC AND TEST CIRCUIT DIAGRAM

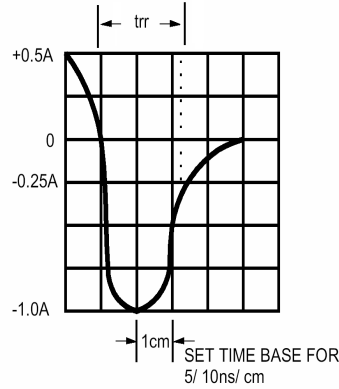
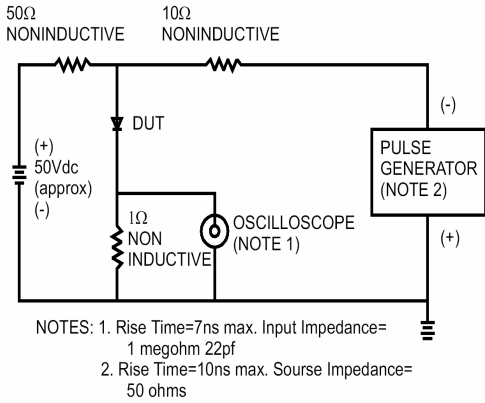

FIG. 2 - TYPICAL FORWARD CURRENT DERATING CURVE

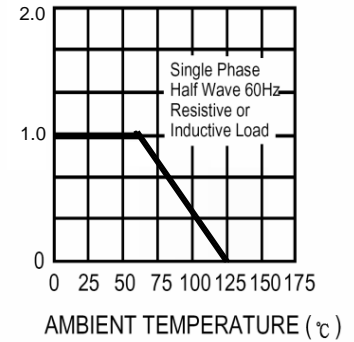

FIG. 3 - TYPICAL REVERSE CHARACTERISTICS

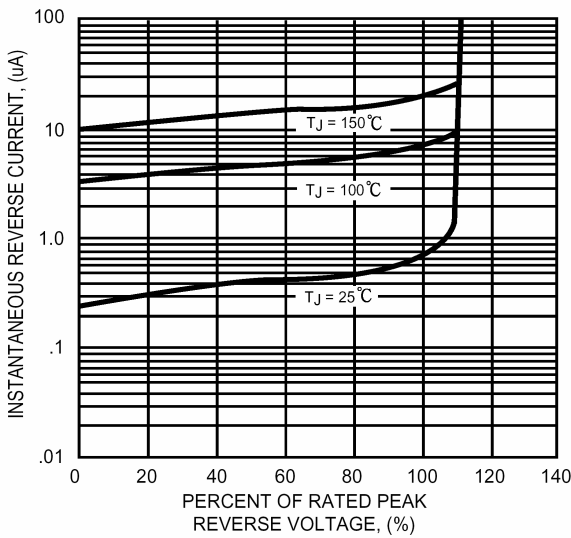

FIG. 4 - TYPICAL INSTANTANEOUS FORWARD CHARACTERISTICS

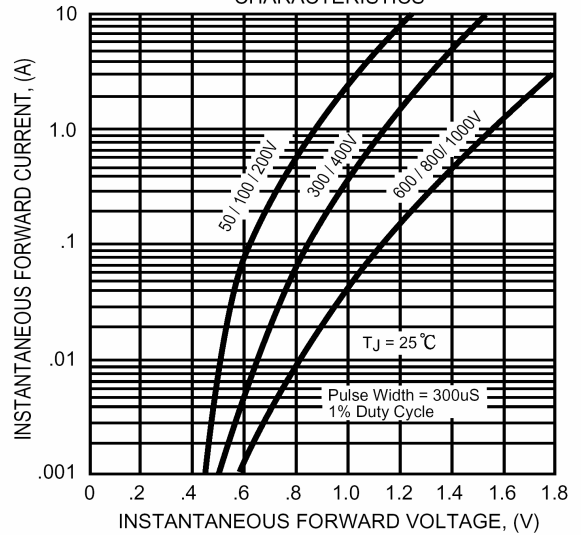

FIG. 5 - MAXIMUM NON-REPETITIVE FORWARD SURGE CURRENT

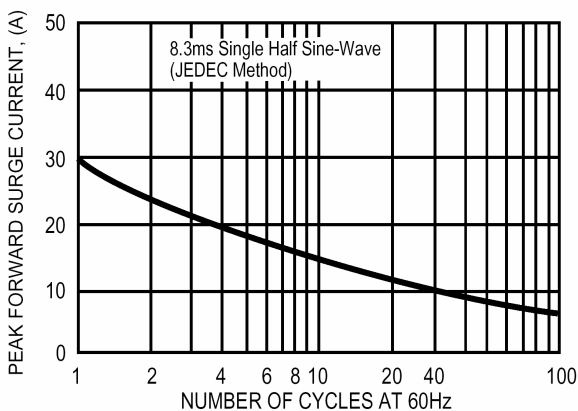

FIG. 6 - TYPICAL JUNCTION CAPACITANCE

